



Item	Value	Remark	
Nominal voltage	220 - 240 V		
Nominal frequency	50 - 60 Hz		
AC voltage range	198 - 264 V		
DC voltage range (start)	NA		
DC voltage range (operation)	NA		
Nominal current	250 mA		
Total Harmonic Distortion (THD)	< 10 %	Full load @230VAC	
Power factor	0.95	Full load @230VAC	
Displacement factor	0.95	Full load @230VAC	
Efficiency	87 % (Typ.)	Full load @230VAC	
No-load power	NA		
Stand-by power	NA		
Networked standby power	< 0.5 W		
Protection class	NA		
Inrush current	20 A / 30 us	Full load @264VAC	
Max.units per circuit breaker	Type B , 10A MCB	16	
	Type B , 16A MCB	26	
	Type C , 10A MCB	20	
	Type C , 16A MCB	32	
Earth leakage current	NA		
Nominal voltage range			
500-1000mA	10 - 42 Vdc		
1050mA	10 - 40 Vdc		
Maximum voltage	57 Vdc		
Output channels	1		
Output	Nominal current range	500 - 1050 mA	DC Output with adjustable constant current from 500 to 1050 mA via NFC in 1mA steps Factory default 500mA
	Current accuracy	± 5 %	Full load @230VAC
	Typical output LF current ripple	± 5 %	Low Frequency < 120Hz Full load @230VAC
	SVM	≤ 0.4	Full load @230VAC
	PstLM	≤ 1	Full load @230VAC
	Starting time	< 1 S	Full load @230VAC, Soft Start
	Nominal power range	5 - 42 W	
	Maximum power	42 W	
Dimming	Dimming control	Wireless	
	Dimming range	1 - 100 %	see the dimming curve
	Lowest dimming current	0.5 - 2 %	@Vo=40-42Vdc
	Dimming technique	Amplitude	
	PWM frequency	NA	
	Galvanic isolation	NA	

Item	Value				Remark	
Ambient temperature range t_a	-	20	°C	- +	45 °C	
Maximum case temperature t_c	90 °C					
Max. case temp. in fault condition	110 °C				When operating under fault conditions, the temperature of the enclosure at any location should not exceed 110 °C	
Storage temperature range	-	40	°C	- +	85 °C	
Relative humidity	10	%	-	95	%	
Surge transient protection	2kV				L/N	
Environmental rating	Indoor					
IP rating	IP20					
Mains switching cycles	>	100,000				
Expected lifetime						
Full load 42W	>	50,000	h, t_c	90 °C @ t_a	45 °C	0.2% / 1,000 h failure rate
Output load \leq 28W	>	45,000	h, t_c	90 °C @ t_a	60 °C	0.22% / 1,000 h failure rate

Packing	Gross weight/box	kg			
	Net weight/box	kg			
	Pcs/box	PCS			
	Dimension/box	(L) *	(W) *	(H)	mm

Protections	
Short-circuit Protection	Auto recovery
Open-circuit Protection	Auto recovery
Overload Protection	Auto recovery

Conformity & Standards	
Safety standard:	EN 61347-1, EN 61347-2-13, EN 62493
Performance:	EN 62384
EMC standard:	EN 55015, EN 61000-3-2, EN 61000-3-3, EN 61547
Wireless standard:	ETSI EN300 328 ,ETSI EN301 489-1,ETSI EN301 489-17

Cable information	PRI Connection			
	Cable cross-section	0.5	-	1.5
Stripping	9 mm			
Cable information	SEC Connection			
	Cable cross-section	0.5	-	1.5
Stripping	9 mm			

Terminal	PRI-	Push button/Angled Entry
	SEC-	Push button/Angled Entry

Subject to change without notice, HEP guarantees all products perform functionally well

* If not mentioned, all the test conditions are based on full load at 230VAC input (for 220-240 VAC input).

Optional product accessories



Wireless modulu	Brand	Model name	APP
	HEP	WBSA	HEPxIDEA
	TUYA	WBSB,WZSB	Smart Life
	CASAMBI	WBSD	CASAMBI

**For optional model, please check out its data sheet for details of specification.

■ Lighting Control APP

The APP can be downloaded on Apple Store and Google Play Store for iOS and Android.

You can search APP name "casambi" "smart life" "HEPxIDEA", or scanning the QR code.



CASAMBI



Android

IOS

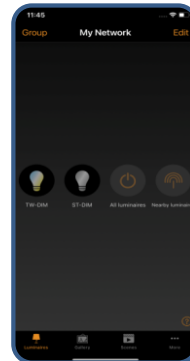
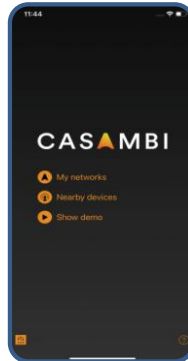

Website : <https://casambi.com/>

Tuya(Smart Life)



Android

IOS

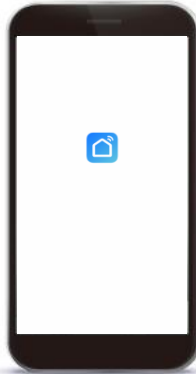

Website : <https://www.tuya.com/cn/>

HEP(HEPxIDEA)



Android

IOS



Website : <http://www.hepgroup.net/zh-tw/a2-4990/HEPxIDEA.html>

Current adjustable

Output current/Color temperature can be adjusted by NFC reader and APP

NFC Reader (optional)

Feature:

Easily on-line read a output current from a driver or write a new current data to a driver throughout HEP NFC reader within few seconds.

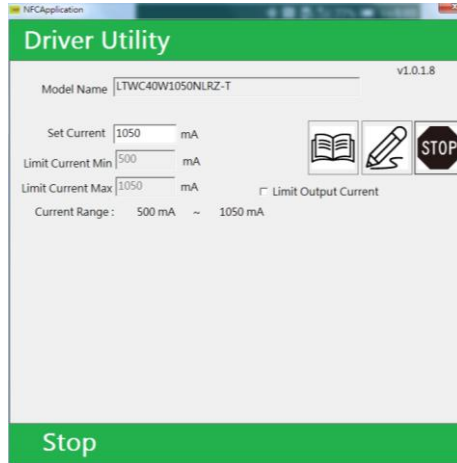

NFC APP

Feature:

Quickly check output current of a LED driver simply via Android smart phone, as well as, correct or setup a new current data immediately with no extra equipment at any job site.

ICON



Main

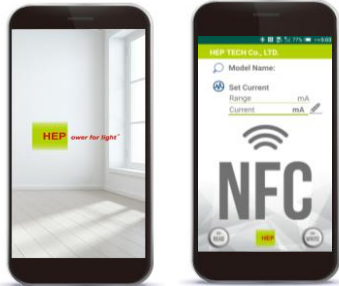

Keep NFC emission of smart phone closed to NFC antenna of LED driver
Touch instantly to tune output current and/or color temperature

QR Code

Google play

APK



Android 4.2 Up
Smart phone with a NFC function

Output Current (mA)	Output Voltage Range (V)	Output Power Range (W)
1050	10-40	10.5-42.0
1000	10-42	10.0-42.0
900	10-42	9.0-37.8
800	10-42	8.0-33.6
700	10-42	7.0-29.4
600	10-42	6.0-25.2
500	10-42	5.0-21.0

* Upon client's special demand, customized current range in between 500 mA and 1050 mA could be specified as factory default from shipment. This default current range availablely revised again via NFC reader program at client's site, if necessary.

V/I Curve

Output Power Range

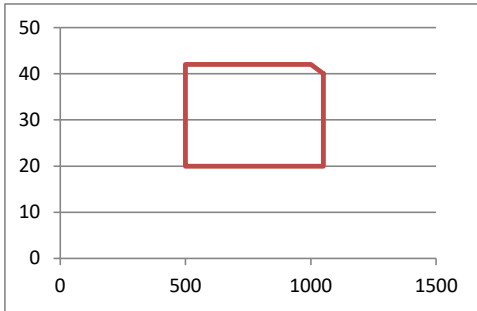

Electrical Values

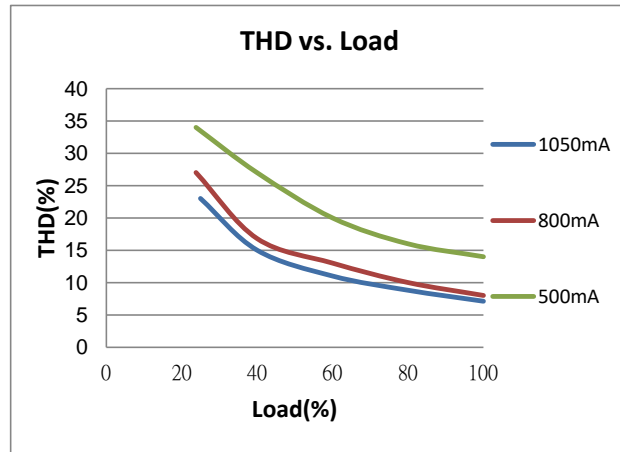
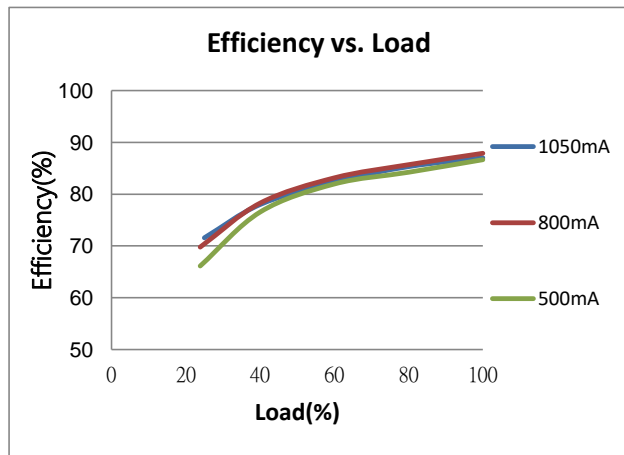
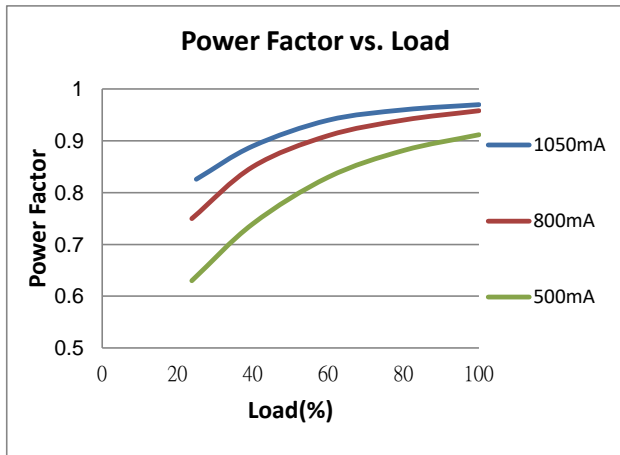

Physical
Parameter

▼ By adding side covers the built-in type simply easy as an independent unit.

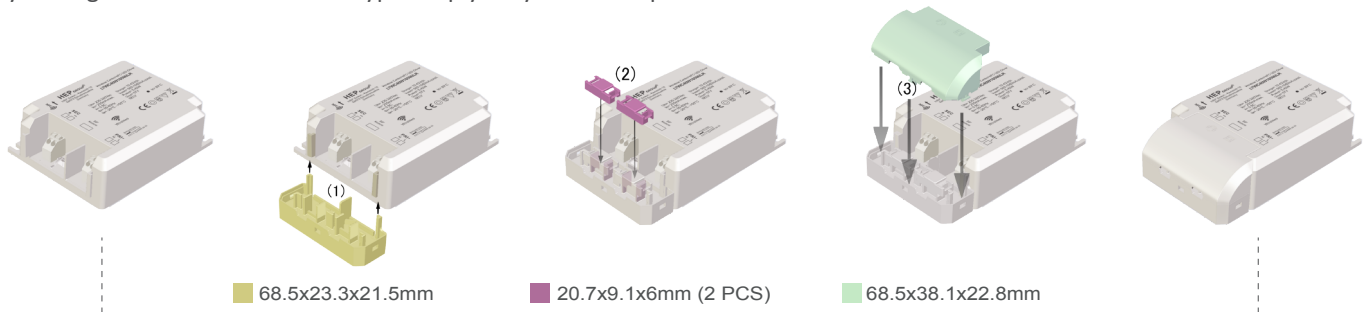

■ 68.5x23.3x21.5mm

■ 20.7x9.1x6mm (2 PCS)

■ 68.5x38.1x22.8mm

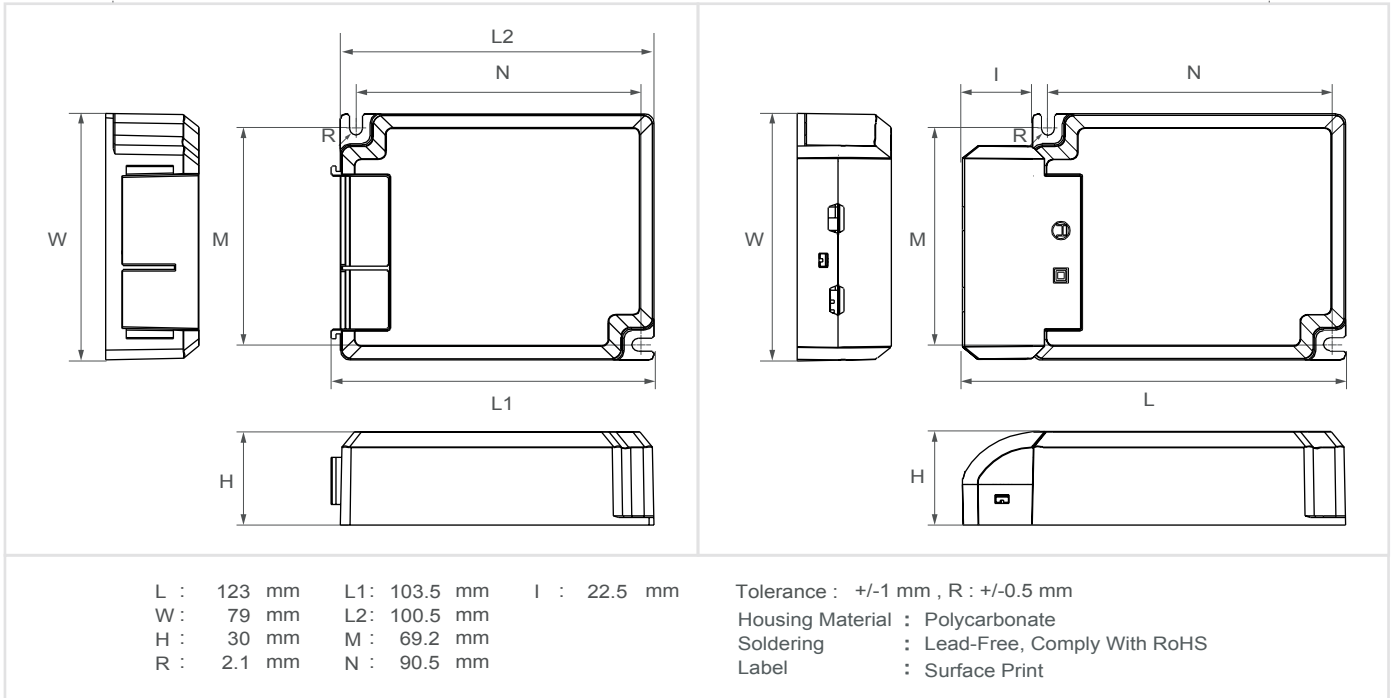

Wiring Diagram

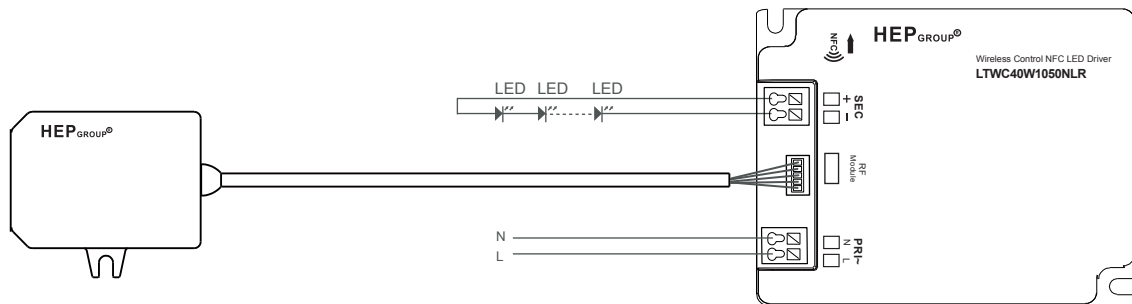

NFC Antenna Location

